

## MAIN FEATURES

Powered by



### Standby Power Rating

225 kVA, 180 kW, 50 Hz

### Prime Power Rating

205 kVA, 164 kW, 50 Hz

Service		Standby <sup>1</sup>	Prime <sup>2</sup>
Speed	(rpm)	1500	
Voltage	(V)	400/231	
Current	(A)	325	295
Power Factor	(CosØ)	0,80	

Industrial Water Cooled

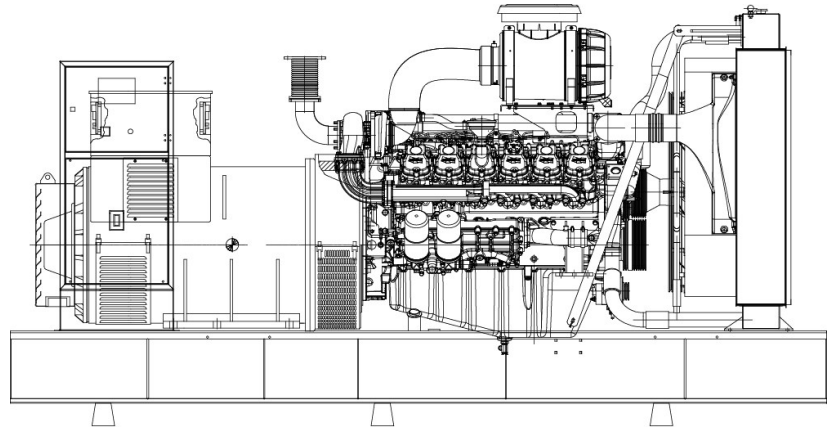

Image used for illustration purposes only

## CODES AND STANDARDS



ISO 9001:2015  
ISO 10002:2018

ISO 14001:2015  
ISO 45001:2018



EN ISO 8528-13:2016  
EN ISO 8528-4  
EN ISO 8528-5  
EN ISO 8528-8  
EN ISO 12100:2010  
EN ISO 13857:2019

EN 60204-1:2018  
EN 60034-1:2010/AC:2010  
EN 61439-1:2011  
EN 61439-2:2011  
EN 61000-6-2:2019  
EN 61000-6-4:2007/A1:2011



TS 12650  
TS ISO 8528-4

TS ISO 8528-5  
TS EN ISO 8528-13



TS EN ISO 9227  
TS EN ISO 2178

TS EN ISO 2409



EN 60204-1:2015  
EN 61000-6-2:2015

EN 61000-6-4:2016  
EN ISO 8528-13:2016



GOST-R 51769:2001  
GOST-R ISO 13849-1:2003  
GOST-R 54145-2010  
GOST-R IEC 62198:2015  
GOST-R 51901-1:2002

GOST-R 15150-69  
GOST-R 51338-99  
GOST-R 2787-75  
GOST-R 24297:2013  
GOST-R 33855:2016

Not all codes and standards apply to all configurations.

Contact factory for details.

## STANDBY POWER<sup>1</sup>

According to ISO 8528-1:2018, emergency standby power is the maximum power available during a variable electrical power sequence, under the stated operating conditions, for which a generating set is capable of delivering in the event of a utility power outage or under test conditions for up to 200 h of operation per year with the maintenance intervals and procedures being carried out as prescribed by the manufacturers. The permissible average power output over 24 h of operation shall not exceed 70% of the ESP. There isn't any overload capability above stand by power rate.

## PRIME POWER<sup>2</sup>

According to ISO 8528-1:2018, prime power is the maximum power which a generating set is capable of delivering continuously whilst supplying a variable electrical load when operated for an unlimited number of hours per year under the agreed operating conditions with the maintenance intervals and procedures being carried out as prescribed by the manufacturer. The permissible average power output over 24 h of operation shall not exceed 70% of the PRP. 10% overload permissible for 1 hour in every 12 hours.

## STANDARD REFERENCE CONDITIONS

Output ratings are presented at 25°C air inlet temperature, barometric pressure 100 kPa, relative humidity 30%. This generating set is designed to operate at high ambient temperatures (up to 50°C), humidity (up to 70%) and higher altitudes. In case of specific site conditions, genset output power may derate. For such conditions please consult your dealer to choose correct product. Some of the specifications are not standard on all genset models



## STANDARD FEATURES

---

### ENGINE

State of the art technology, water cooled, four stroke heavy duty high performance industrial type diesel engine.

### COOLING SYSTEM

Made of quality industrial type radiator, expansion tank and cooling fan keeps the engine system at the appropriate temperature of the generator equipment. Radiator and cooling fan, complete with safety guards, designed to cool the engine at high ambient temperatures.

### ELECTRICAL SYSTEM

Battery group (12V or 24V), redresser, battery tray and cables are provided with genset. The charging alternator is mounted on the engine and is driven by a belt-pulley. DC starting motor to crank the engine is available mounted on the engine.

### FUEL SYSTEM

On Generating Sets up to 1250 kVA, the base-frame design is incorporated with an integral fuel tank with a capacity of approx. 8 hours running at full load. The tank is supplied complete with fill cap breather, fuel level gage, fuel feed and return lines to the engine and drain plug. Higher capacities and double-walled fuel tanks are also available as an option.

### LUBRICATION SYSTEM

Our diesel generators feature an efficient oil pump and integrated filtration system, ensuring optimal lubrication and removal of impurities from the engine oil. Equipped with low oil pressure sensors, they automatically trigger an emergency shutdown to protect the engine in critical situations. This advanced oil management system reduces friction among moving parts, extending the engine's lifespan and ensuring reliable performance. With these features, our generators offer superior protection and efficiency, making them an excellent choice for your power needs.

### EXHAUST SILENCER

Heavy duty steel industrial type exhaust silencer. Silencer noise reduction level is 10-15 dB(A). Higher capacity silencers also available as residential, critical or hospital types as option.

### CUSTOMIZED SOLUTIONS

KJ Power customized power systems, as tailor made production built and tested by a dedicated team of experienced engineers and technicians, which means it can meet the most demanding specifications. When you combine our industry experience with our agile manufacturing process, you get reliable, purpose-built solutions.

### SOUND ATTENUATED CANOPIES

Sound insulated canopies are produced from galvanized sheets in accordance with rust and harsh weather conditions, as modular design canopies are cleaned with a special process and painted with electrostatic powder paint. KJ Power canopies have a modular structure that can be easily disassembled, providing the group with easy service and maintenance and on-site parts replacement. At the same time, the canopies are designed to take into account the cooling performance and power output value of the generator set according to the ambient temperature, and are designed to not cause any power drop during operation. Canopies are produced after prototype tests are carried out for suitability to ambient temperature and sound level.

Container type and super silent canopies are also offered optionally according to customer demand.

### ALTERNATOR

Synchronous 4 Poles, 3 phase, self excited, brushless alternators are designed to offer you the best power generation performances. The insulation system is Class H. All windings are impregnated in either a triple dip thermosetting liquid, oil and acid resisting polyester varnish or vacuum pressure impregnated with a special polyester resin. Heavy coating of antitracking varnish provides additional protection against moisture or condensation. The fully sealed Automatic Voltage Regulator (AVR) maintains voltage regulation up to  $\pm 1\%$  nominal adjustment by means of a trim pot incorporated on AVR. When the PMG or AREP option is installed, an overload capacity equivalent to 300% of the full load impedance can be sustained for 10 seconds at Power Factor "Cos $\phi$  = 1".

### FACTORY ACCEPTANCE TESTS

All generator sets manufactured at KJ Power facilities are subjected to load testing before being shipped. Control functions of all protective devices and field load conditions are implemented by simulation.

### DOCUMENTATION

Maintenance and user manuals related with engine, generator and controller. Wiring diagram/Electric schematic.

### WARRANTY

All our generator sets are covered by a warranty against manufacturing defects in materials and workmanship. The warranty conditions, which also cover the equipment on the generator, vary according to the local conditions of the country where the product is operated.



## STANDARD FEATURES

DATAKOM (STANDARD)



DEEPSEA



COMAP



DEIF



### ADVANCED GENSET CONTROLLERS

The Genset Control Unit is an Auto Start Control Module for single genset applications. It includes a backlight LCD display which clearly shows the status of the engine all the times. This module can either be programmed using the front panel or by using the AMF configuration suite PC software.

Datakom D-500 MK3 controller is suitable to convert synchronization controller with plugin module.

### METERING & ALARM INDICATORS

- Generator volts (L-L, L-N)
- Generator frequency
- Underspeed, Overspeed
- Generator current
- Engine oil pressure
- Engine coolant temperature
- Fuel level (Warning or shutdown)
- Hours run counter
- Battery voltage
- Fail to start/stop
- Emergency stop
- Failed to reach loading voltage / frequency
- Charge fail
- Loss of magnetic pick-up signal

### COMMUNICATIONS

- Modbus RS-485, Modbus TCP/IP (optional)
- Ethernet, GSM-GPRS (optional)
- Internal GPRS modem (optional)
- Embedded web server (optional)
- Web monitoring, Web programming (optional)
- GSM-SMS (optional)
- Email (optional)
- SNMP (optional)
- USB host (optional)
- USB device
- RS-485 (optional)
- RS-232 (optional)
- Micro SD card slot (optional)
- J1939-CANBUS

### CONTROLLERS FUNCTION

- AMF function
- Contactor/CB control outputs for ATS load transfer
- Remote start
- Manual start
- Engine controller
- Remote display & control unit (optional)
- Waveform display of V & I
- Harmonic analysis of V & I
- Current transformers at genset or load side

KJ Power uses state of the art technology genset control units like Datakom, Deepsea, Comap and Deif combining multi-functionality and wide communication possibilities together with a reliable design. These units comply and mostly exceed world's tightest safety, EMC, vibration and environmental standards for the industrial category. Software features are complete with easy firmware upgrade process through USB port. The Windows based PC software allows monitoring and programming through USB, RS-485, Ethernet and GPRS. The PC based Scada softwares allows monitoring and control of an unlimited number of gensets from a single central location.



## STANDARD FEATURES

---

- 4 stroke 1500RPM, water cooled heavy duty diesel engine
- Dry type replacable air filter
- Heat-resistant radiator for 50 °C
- Flexible oil pipes and oil draining valve
- Pre-heater 4 poles synchronotype, single bearing, brushless alternator
- Batteries and cables
- Electrostatic paint coated, steel, welded chassis
- Fuel tank housed in the chassis Industrial type silencer
- Electronic battery charger
- Electrical wiring diagram
- User manual and operating manual
- Protection system on manual run
- Lubrication oil and anti - freeze

## OPTIONAL FEATURES

---

- Soundproof canopy
- Automatic transfer switch
- Circuit Breaker
- Trailer
- External fuel tank
- Electronic governor
- Heating system for fuel tank
- Oil heater
- Fuel filling system (Automatic / Manual)
- Analog indicators
- 1 Phase - 3 phase switch plugs
- Alarm system for fuel level
- Remote control and monitoring



## ENGINE SPECIFICATIONS

Model		SC7H250D2
Speed	(rpm)	1500
Prime Power, net	(kWm)	161
Standby Power, net	(kWm)	178
Cycle		Diesel, 4 Stroke
Emission Standard		Chinese Stage II
Injection System		Direct
Governor		Electronic
Intake Air Aspiration & Configuration		Turbocharged
Number Of Cylinder		6 - In-line
Bore x Stroke	(mm)	105 x 124
Displacement	(l)	6,440
Fuel Consumption	@ 100% Load	(l/h) 39,3
	@ 75% Load	(l/h) 29,1
	@ 50% Load	(l/h) 19,4
Starting System	(VDC)	24
Cooling System		Water Cooled
Coolant Capacity	(l)	31,1
Lube Oil Capacity	(l)	17,5

## GENSET CONTROLLER

Controller		Datakom
Model		D-500 MK3

## ALTERNATOR SPECIFICATIONS

Prime Power	(kVA)	205
Standby Power	(kVA)	225
Poles		4
Number Of Phase		3
Number Of Bearing		Single
Insulation Class		H
Number Of Wires		12/6
Winding Pitch		2/3
Protection Class		IP23
Cooling		Self Ventilating
Voltage Regulator		Electronic AVR
Steady State Voltage Regulation	(%)	±±1
THD (No Load)	(%)	< < 1,5
THD (Linear Load)	(%)	<
Excitation		Self Excitation



**CANOPY TYPE DIMENSIONS**

Weight	(kg)	2123
--------	------	------

(\*) The unit of dimensions is "mm".

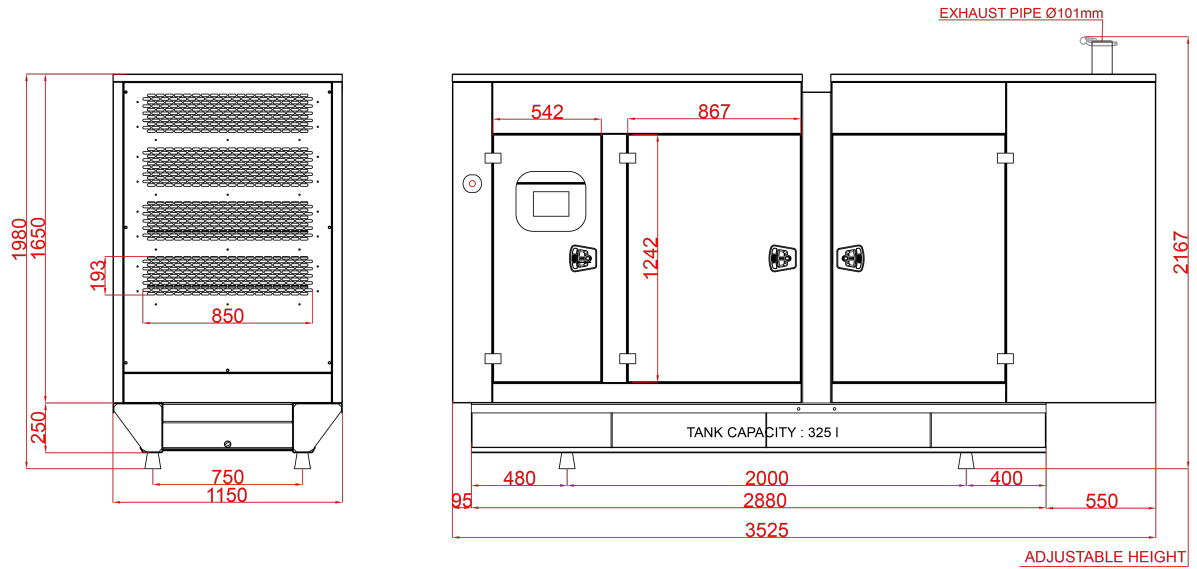

**OPEN TYPE DIMENSIONS**

Weight	(kg)	1693
--------	------	------

